

## Utility Trays

- Multipurpose Utility Trays neatly organize kitchen utensils, craft supplies, tools and more
- Cosmetic Tray organizes cosmetics and small items into 5 easy-to-access rows and compartments
- Durable, high gloss white polystyrene cleans up easily and can be cut to fit

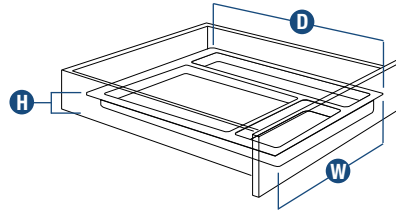

**Multipurpose Utility Tray**  
(UT1217-W shown)



**UT1217-W**



**Cosmetic Tray**  
(COS2075-W shown)

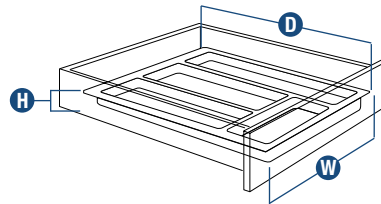

**UT1517-W & UT1817-W**

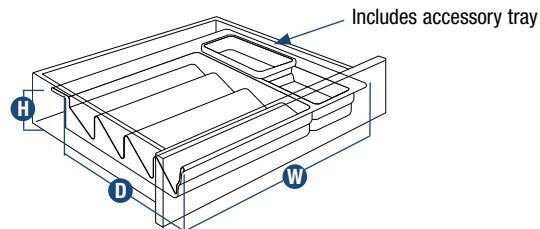

**COS2075-W**

Stock #	Height <b>H</b>	Width <b>W</b>	Depth <b>D</b>	Finish	Units per Carton	Weight per Carton
<b>MULTI-PURPOSE UTILITY TRAYS</b>						
UT1217-W	2-3/16" [56 mm]	12-3/8" [314 mm] to 14-3/4" [375 mm]	17-3/8" [441 mm] to 21" [533 mm]	White	10	11.2 lbs. [5.1 kg.]
UT1517-W	2-3/16" [56 mm]	15-5/16" [389 mm] to 17-3/4" [451 mm]	17-5/16" [440 mm] to 21" [533 mm]	White	10	12.7 lbs. [5.8 kg.]
UT1817-W	2-3/16" [56 mm]	18-3/8" [467 mm] to 21-1/8" [537 mm]	17-5/16" [440 mm] to 21" [533 mm]	White	10	14.2 lbs. [6.4 kg.]
<b>COSMETIC TRAY</b>						
COS2075-W	2-7/8" [73 mm]	5" [127 mm] to 21-1/2" [546 mm]	16-1/4" [413 mm] to 21" [533 mm]	White	1	2.5 lbs. [1.1 kg.]

See page 45 for compartment information. See page 46 for minimum drawer dimensions.

# Drawer Insert Diagrams

## DOUBLE-TIERED TABLEWARE TRAYS

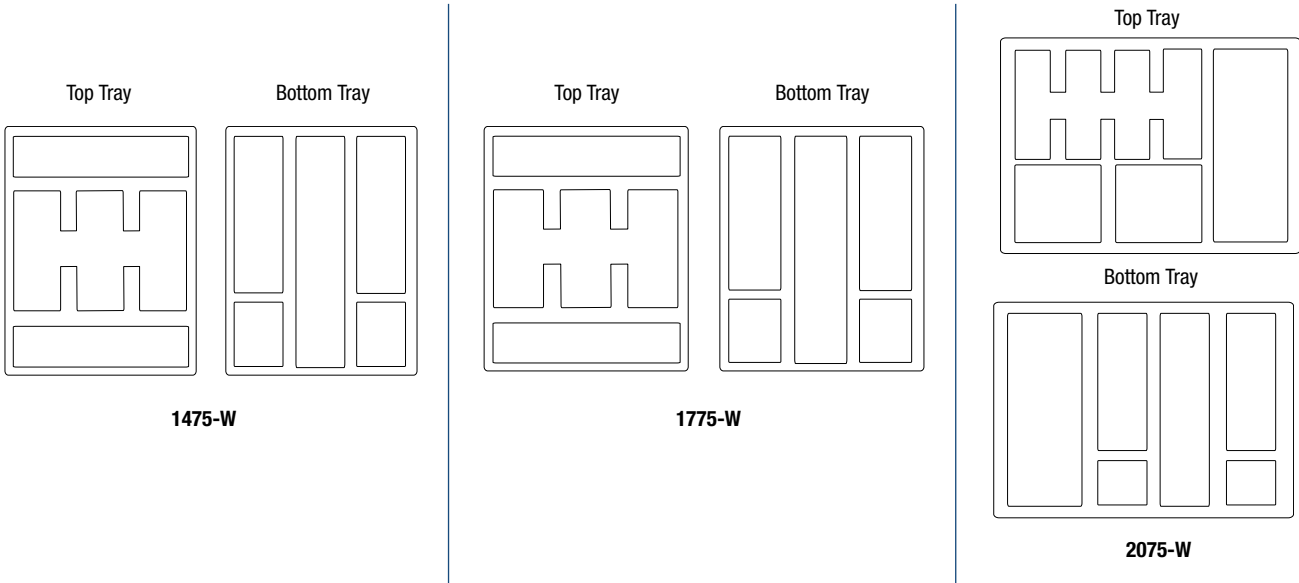

## SINGLE-TIERED TABLEWARE TRAYS

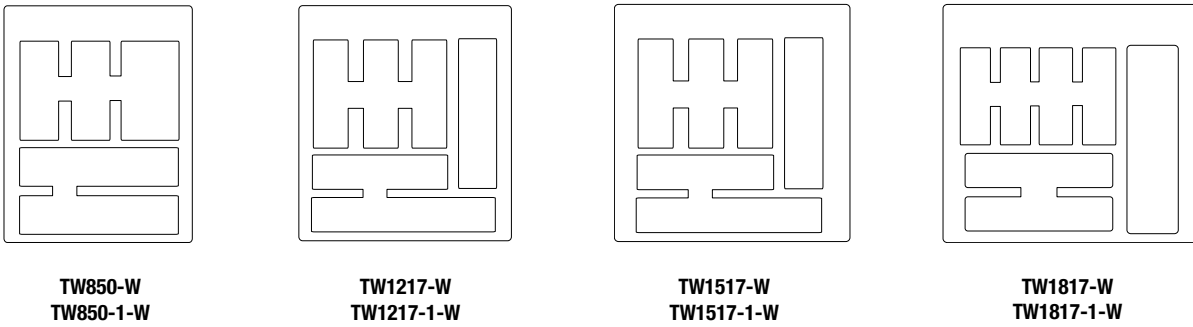

## MULTIPURPOSE UTILITY TRAYS

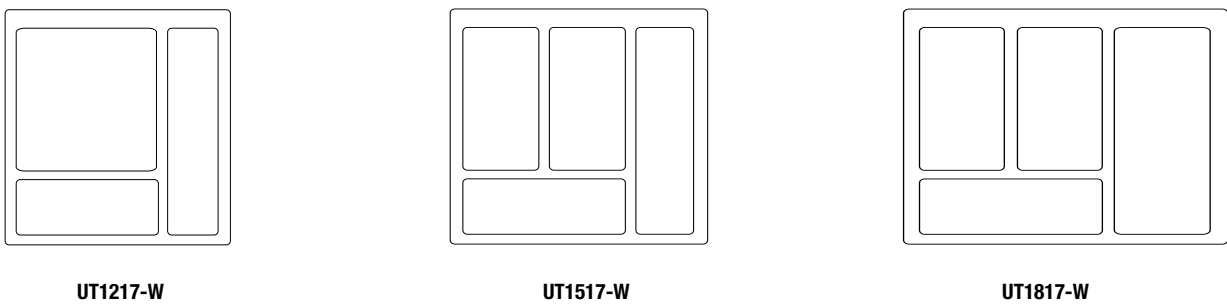

# Cabinet Dimensions

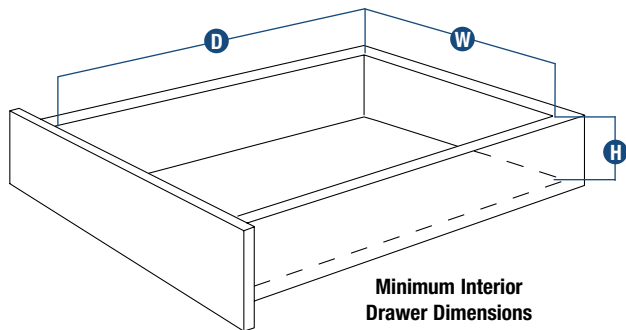

**Minimum Interior  
Drawer Dimensions**

Stock #	Height <b>H</b>	Width <b>W</b>	Depth <b>D</b>
<b>DOUBLE-TIERED TABLEWARE TRAYS (with removable top tray)</b>			
1475-W	3-3/4" [95 mm]	12-1/4" [311 mm]	17-1/4" [438 mm]
1775-W	3-3/4" [95 mm]	15-1/4" [387 mm]	17-1/4" [438 mm]
2075-W	3-3/4" [95 mm]	18-1/4" [464 mm]	17-1/4" [438 mm]
<b>SINGLE-TIERED TABLEWARE TRAYS</b>			
TW850-W	2-7/16" [62 mm]	8-3/4" [222 mm]	17-5/16" [440 mm]
TW1217-W	2-3/8" [60 mm]	12-3/8" [314 mm]	17-5/16" [440 mm]
TW1517-W	2-3/8" [60 mm]	15-5/16" [389 mm]	17-5/16" [440 mm]
TW1817-W	2-3/8" [60 mm]	18-3/8" [467 mm]	17-3/8" [441 mm]
TW850-1-W	2-7/16" [62 mm]	8-3/4" [222 mm]	17-5/16" [440 mm]
TW1217-1-W	2-3/8" [60 mm]	12-3/8" [314 mm]	17-5/16" [440 mm]
TW1517-1-W	2-3/8" [60 mm]	15-5/16" [389 mm]	17-5/16" [440 mm]
TW1817-1-W	2-3/8" [60 mm]	18-3/8" [467 mm]	17-3/8" [441 mm]
<b>MULTIPURPOSE UTILITY TRAYS</b>			
UT1217-W	2-7/16" [62 mm]	12-3/8" [314 mm]	17-3/8" [441 mm]
UT1517-W	2-7/16" [62 mm]	15-5/16" [389 mm]	17-5/16" [440 mm]
UT1817-W	2-7/16" [62 mm]	18-3/8" [467 mm]	17-5/16" [440 mm]
<b>COSMETIC DRAWER TRAYS</b>			
COS2075-W	3-1/8" [79 mm]	5" [127 mm]	16-1/4" [413 mm]
<b>WOOD SPICE TRAYS</b>			
SPICETRAY10	2-1/16" [52 mm]	10-1/4" [260 mm]	19-5/8" [498 mm]
SPICETRAY13	2-1/16" [52 mm]	13-1/4" [337 mm]	19-5/8" [498 mm]
SPICETRAY16	2-1/16" [52 mm]	16-1/4" [413 mm]	19-5/8" [498 mm]
SPICETRAY19	2-1/16" [52 mm]	19-1/4" [489 mm]	19-5/8" [498 mm]
<b>POLYMER SPICE TRAYS</b>			
SDG1088-1-W	2-1/4" [57 mm]	12-1/8" [308 mm]	16-1/4" [413 mm]
SDG1088-W	2-1/4" [57 mm]	12-1/8" [308 mm]	16-1/4" [413 mm]

Stock #	Height <b>H</b>	Width <b>W</b>	Depth <b>D</b>
<b>STEEL SINK FRONT TRAYS (without stops)</b>			
SF10	3-1/2" [89 mm]	10-9/16" [268 mm]	2-1/2" [64 mm]
SF11	3-1/2" [89 mm]	11-13/16" [300 mm]	2-1/2" [64 mm]
SF13	3-1/2" [89 mm]	13-9/16" [344 mm]	2-1/2" [64 mm]
SF14	3-1/2" [89 mm]	14-1/2" [368 mm]	2-1/2" [64 mm]
SF16	3-1/2" [89 mm]	16-9/16" [421 mm]	2-1/2" [64 mm]
SF19	3-1/2" [89 mm]	19-9/16" [497 mm]	2-1/2" [64 mm]
SF22	3-1/2" [89 mm]	22-9/16" [573 mm]	2-1/2" [64 mm]
SF25	3-1/2" [89 mm]	25-9/16" [649 mm]	2-1/2" [64 mm]
SF28	3-1/2" [89 mm]	28-9/16" [725 mm]	2-1/2" [64 mm]
SF31	3-1/2" [89 mm]	31-9/16" [802 mm]	2-1/2" [64 mm]
ESF10-W	3-1/2" [89 mm]	10-9/16" [268 mm]	2-1/2" [64 mm]
ESF13-W	3-1/2" [89 mm]	13-9/16" [344 mm]	2-1/2" [64 mm]
ESF14-W	3-1/2" [89 mm]	14-1/2" [368 mm]	2-1/2" [64 mm]
ESF16-W	3-1/2" [89 mm]	16-9/16" [421 mm]	2-1/2" [64 mm]
ESF19-W	3-1/2" [89 mm]	19-9/16" [497 mm]	2-1/2" [64 mm]
ESF22-W	3-1/2" [89 mm]	22-9/16" [573 mm]	2-1/2" [64 mm]
ESF25-W	3-1/2" [89 mm]	25-9/16" [649 mm]	2-1/2" [64 mm]
ESF28-W	3-1/2" [89 mm]	28-9/16" [725 mm]	2-1/2" [64 mm]
ESF31-W	3-1/2" [89 mm]	31-9/16" [802 mm]	2-1/2" [64 mm]
<b>STEEL SINK FRONT TRAYS (with stops)</b>			
SF10W	3-1/2" [89 mm]	12-1/8" [308 mm]	3-1/2" [89 mm]
SF11W	3-1/2" [89 mm]	13-3/8" [340 mm]	3-1/2" [89 mm]
SF13W	3-1/2" [89 mm]	15-1/8" [384 mm]	3-1/2" [89 mm]
SF14W	3-1/2" [89 mm]	16-1/16" [408 mm]	3-1/2" [89 mm]
SF16W	3-1/2" [89 mm]	18-1/8" [460 mm]	3-1/2" [89 mm]
SF19W	3-1/2" [89 mm]	21-1/8" [537 mm]	3-1/2" [89 mm]
SF22W	3-1/2" [89 mm]	24-1/8" [613 mm]	3-1/2" [89 mm]
SF25W	3-1/2" [89 mm]	27-1/8" [689 mm]	3-1/2" [89 mm]
SF28W	3-1/2" [89 mm]	30-1/8" [765 mm]	3-1/2" [89 mm]
SF31W	3-1/2" [89 mm]	33-1/8" [841 mm]	3-1/2" [89 mm]
ESF10W-W	3-1/2" [89 mm]	12-1/8" [308 mm]	3-1/2" [89 mm]
ESF11W-W	3-1/2" [89 mm]	13-3/8" [340 mm]	3-1/2" [89 mm]
ESF13W-W	3-1/2" [89 mm]	15-1/8" [384 mm]	3-1/2" [89 mm]
ESF14W-W	3-1/2" [89 mm]	16-1/16" [408 mm]	3-1/2" [89 mm]
ESF16W-W	3-1/2" [89 mm]	18-1/8" [460 mm]	3-1/2" [89 mm]
ESF19W-W	3-1/2" [89 mm]	21-1/8" [537 mm]	3-1/2" [89 mm]
ESF22W-W	3-1/2" [89 mm]	24-1/8" [613 mm]	3-1/2" [89 mm]
ESF25W-W	3-1/2" [89 mm]	27-1/8" [689 mm]	3-1/2" [89 mm]
ESF28W-W	3-1/2" [89 mm]	30-1/8" [765 mm]	3-1/2" [89 mm]
ESF31W-W	3-1/2" [89 mm]	33-1/8" [841 mm]	3-1/2" [89 mm]

Dimensions shown are recommended minimum interior drawer and door opening dimensions. Minimum interior drawer dimensions allow for 1/8" clearance and 3/8" lip on all sides of drawer inserts.