



MISSING A PART?

There is no need to return this item to the store.
Instead call our TOLL FREE HOTLINE:

1-800-253-1561

We appreciate your purchase of the HyLoft® 27" x 36" Ceiling Storage Unit. Knapé & Vogt has made every effort to supply a quality product that insures a lifetime of trouble-free service. In the event that you have any type of problems, and BEFORE RETURNING THE UNIT TO THE SELLER, please call our toll free number 1-800-253-1561.

HyLoft 27" x 36" Ceiling Storage Unit Limited Warranty

Knapé & Vogt warrants this product against defects in the material or workmanship for the life of the product. Knapé & Vogt agrees to either repair the product or replace it at the sole discretion of Knapé & Vogt. This warranty does not include any costs associated with the physical installation, removal, or return of the HyLoft 27"x 36" Ceiling Storage Unit.

This warranty is valid and enforceable provided that the maximum weight supported by each 27"x 36" HyLoft Ceiling Storage Unit does not exceed 150 pounds, evenly distributed. The customer, dealer, and/or installer releases Knapé & Vogt of all claims, which includes the HyLoft unit and the structure it is attached to, if the loaded weight exceeds 150 pounds. The unit must also be installed according to the manufacturer's instructions. At no time should you install more than two HyLoft units on any two ceiling beams (rafters, studs, roof trusses, etc.). All fasteners must be checked and tightened at least annually.

Only the original purchaser of this product is extended this warranty. No warranty work will be provided under this warranty without purchaser's original receipt or other proof of the date of the original purchase acceptable to Knapé & Vogt. Proof of the date of purchase must be provided to Knapé & Vogt if the product is returned.

This Knapé & Vogt limited warranty covers product failure due to defects in materials or workmanship ONLY! It does not cover corrosion, rust or discoloration of it's components, or product failure due to misuse, abuse, faulty installation, alteration, lack of reasonable care, or any other failure not related to the defects in materials or workmanship.

There are NO other warranties expressed or implied except those stated herein as required by applicable law.

KNAPÉ & VOGT SHALL NOT BE LIABLE FOR INCIDENTAL, SPECIAL, OR CONSEQUENTIAL DAMAGES RESULTING FROM THE USE OF THE PRODUCT OR ARISING OUT OF ANY BREACH OF THIS WARRANTY.

ALL IMPLIED WARRANTIES, IF ANY, INCLUDING IMPLIED WARRANTIES OR MERCHANTABILITY AND FITNESS FOR A PARTICULAR PURPOSE, ARE LIMITED TO THE DURATION OF THIS WARRANTY.

Some states do not allow the exclusion or limitation of incidental or consequential damages, or limitations on how long an implied warranty lasts, so the above exclusions or limitations may not apply to you. No other warranty, written or verbal, will be honored for this product. This warranty gives you the specific legal rights and you may also have other rights that vary from state to state.

Knapé & Vogt is not responsible for damages of merchandise in transit. Repaired or replaced products shall be subject to the terms of this warranty, to be inspected by Knapé & Vogt prior to return shipment. Damages incurred during transit should be reported at once to the carrier and a claim should be filed with them.

Knapé & Vogt®
Grand Rapids, MI 49505 U.S.A.

**For more information, accessories, and frequently asked questions, visit the HyLoft website:
www.HyLoft.com**

US Patents: 7152535 & D470353
Australian Patents: 2005211415



ASSEMBLY INSTRUCTIONS

27" x 36" Ceiling Storage Unit

MISSING A PART?





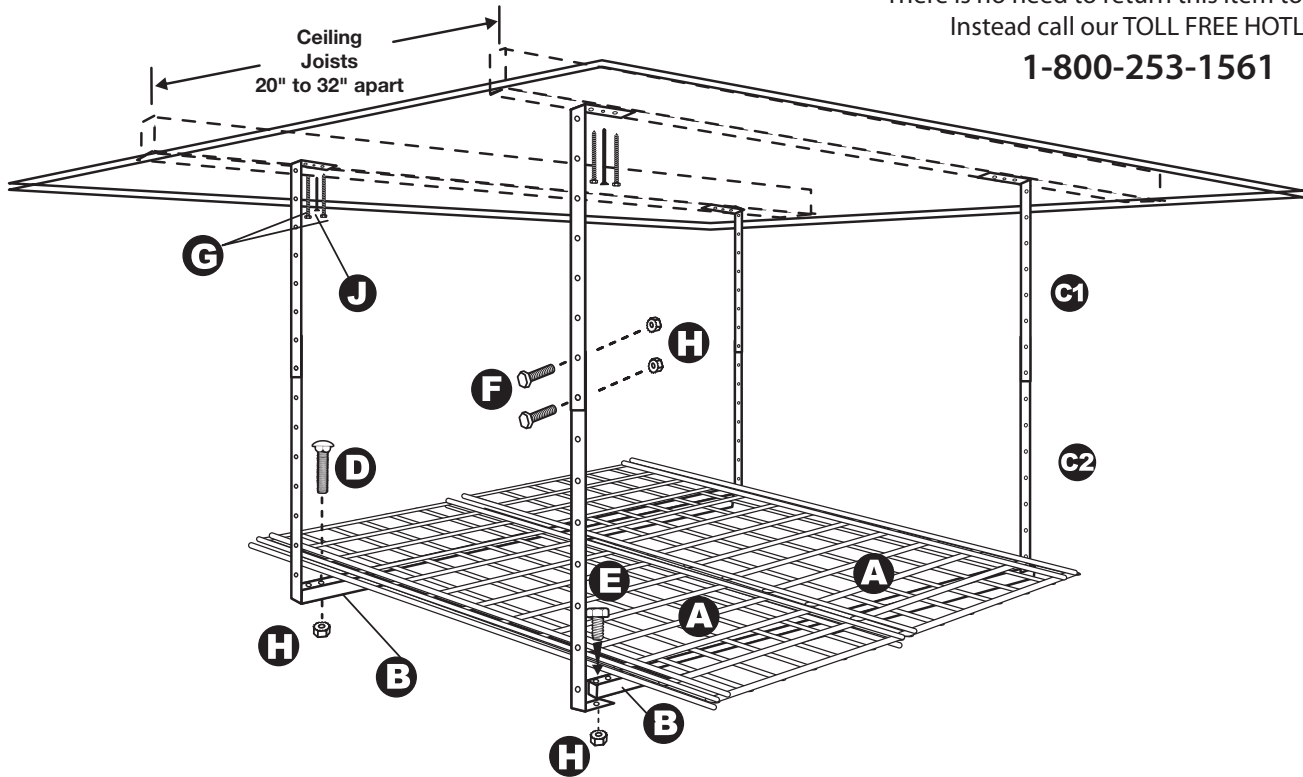



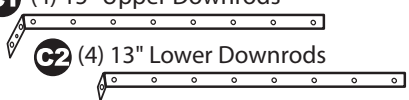

There is no need to return this item to the store.
Instead call our TOLL FREE HOTLINE:

1-800-253-1561

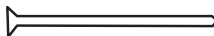

Parts Included

IMPORTANT: Read through entire instructions before beginning any installation.

<p>A (2) Wire Grids 13-1/2" wide</p> 	<p>B (2) Crossbars</p> 	<p>C1 (4) 15" Upper Downrods</p> <p>C2 (4) 13" Lower Downrods</p> 
<p>D (4) Carriage Bolts 1/4" x 2"</p> 	<p>E (4) Hex Bolts 1/4" x 1-1/2"</p>  <p>Use 7/16" Wrench</p>	<p>F (8) Hex Bolts 1/4" x 1/2"</p>  <p>Use 7/16" Wrench</p>
<p>G (8) Lag Screws 5/6" x 2-1/2"</p>  <p>Use 1/2" Wrench</p>	<p>H (16) 1/4" Flange Nuts</p>  <p>Use 7/16" Wrench</p>	<p>I (2) Plastic Tie Straps</p> 
<p>J (4) Stinker Nails</p> 	<p>K (4) Plugs for Crossbars</p> 	<p>L HyLoft Sticker</p>  <p>1-800-253-1561 www.hylotf.com</p>

Tools Required:



Hammer



3/16" Drill Bit



Hand or Power Drill



(1) 7/16" & (1) 1/2" Wrench, Socket Wrench or Nut Driver

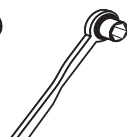

Stud/Joist Finder (optional)

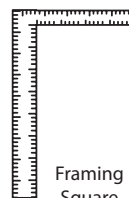

Framing Square (optional)



Pencil



Eye Protection



Tape Measure



Ladder or Step Stool

Installation Time: Approximately 30 minutes

Important: Read through entire instructions before beginning any installation.

Determine where the HyLoft 27" x 36" unit will be installed, such as in a pantry, bedroom, laundry room, closet or garage. (If installing above the open garage door you will need at least 15.5" of open space between the highest point of door and the ceiling as measured during it's upward travel.)

Map out the ceiling area of the room where you are installing your unit. Locate the ceiling joists in the area of desired installation and determine the direction in which they are running. In order to adequately disperse the stored load, you should install no more than two HyLoft 27" x 36" units on any two ceiling rafters (joists, roof trusses, etc.). **IMPORTANT:** The opposite and adjacent ceiling Bent Downrods must be installed in line with each other so that the four Downrods form a perfect square. Refer to the diagram below or photos on the package for additional installation clarification.

Make sure Sinker Nails and Lag Screws are fastened into joists.

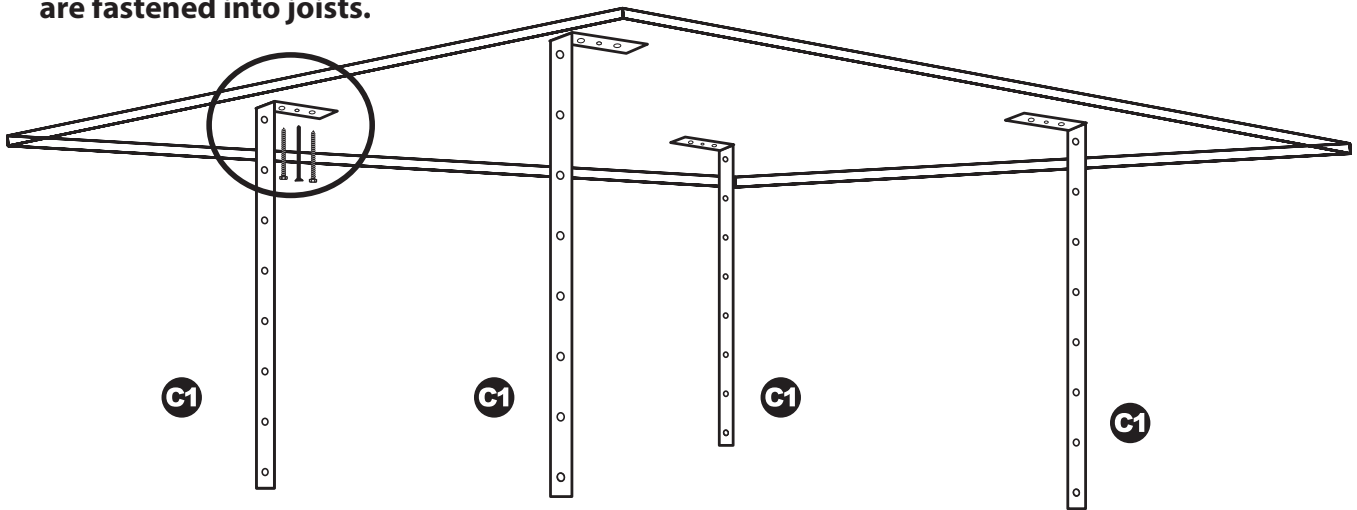

IMPORTANT: Do not over-tighten the Lag Screws (max 10 ft. lbs.). They only need to be fully seated, no more. Do not use an impact driver.

1. Attach Downrods

1A: Attach the first Upper Downrod (C1) into Ceiling Joist. Install a Sinker Nail (J) in the center hole to hold in place and test that it is in the joist. Pre-drill 3/16" holes for the (2) Lag Screws (G). Rub some bar soap or add a drop of liquid soap to the threads of the Lag Screw to ease installation. Use a 1/2" socket wrench or nut driver to install two of the 5/16" x 2-1/2" Lag Screws (G). Locate another joist from 20" to 32" away. Install the second Upper Downrod (C1) making sure it is perfectly in line and square with the first Upper Downrod (C1).

1B: Measure 29-7/8" along the stud from the outside edge of the Upper Downrod (C1) to locate the outside edge of the opposite Upper Downrod, or use the holes in the Crossbars (B) as a template to locate the screw hole locations for the opposite Upper Downrod (C1). Mark with pencil. Repeat for final Upper Downrod (C1).

2. Attach Crossbars and Adjust Height

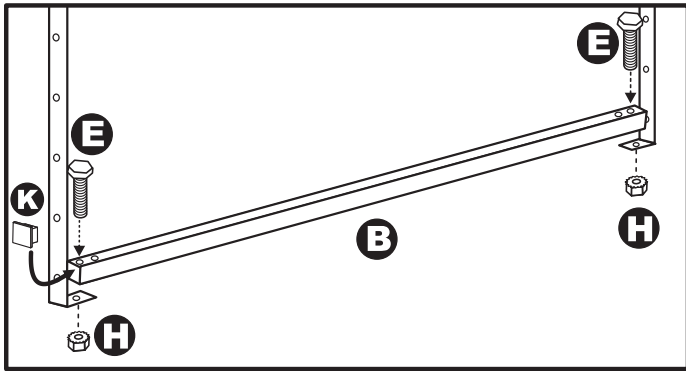

2A: Insert the (4) Plugs (K) into the ends of each Crossbar (B). Connect each Crossbar (B) to (2) Downrods (C2) through first hole from the ends using 1/4" x 1-1/2" Hex Bolts (E) and Flange Nuts (H).

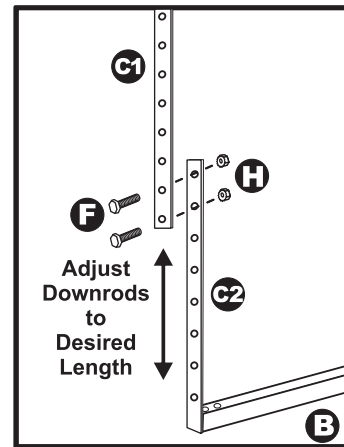

2B: Connect Crossbar (B) and Lower Downrods (C2) to Upper Downrods (C1) at desired height using (2) 1/4" x 1/2" Hex Bolts (F) and Flange Nuts (H) in each. Be sure to install the second support bar assembly parallel and in line with the first.

3. Place and Attach Grids

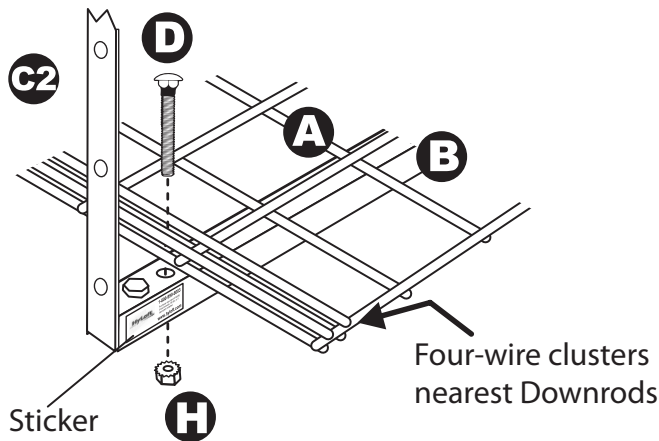

3A: Lay Wire Grids (A) evenly on Crossbars (B) and attach with Carriage Bolts (D) and Flange Nuts (H). **Note:** Long grid wires are on the bottom and extend past support bars equally on both sides.

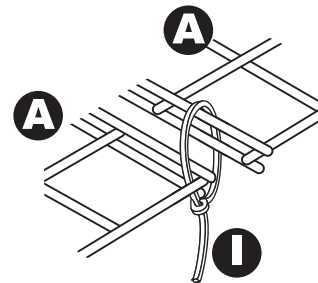

3B: Fasten Wire Grids (A) together using (2) Plastic Tie Straps (I).

You have now completed the installation and are ready to load your new HyLoft Storage Unit. **(Maximum 150 lbs. per 27" x 36" unit, evenly distributed).**

Place the HyLoft Sticker (L) provided on a support bar for easy reference information.

Periodically (at least annually) check all connections to ensure that they remain tightly fastened.